

STRETSJING 2

62802

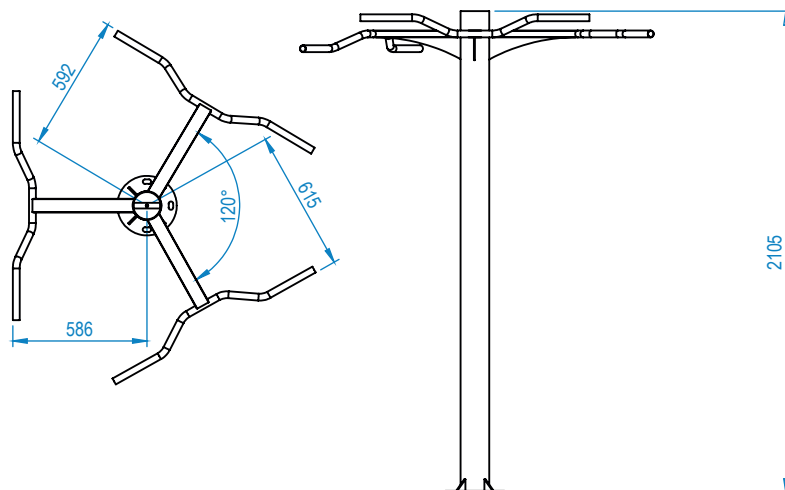

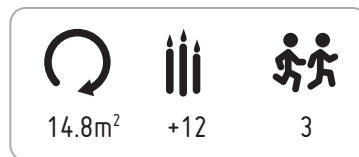
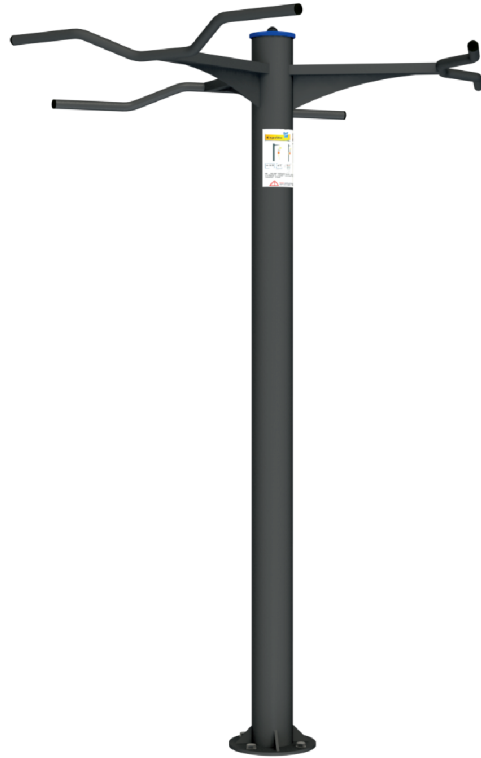
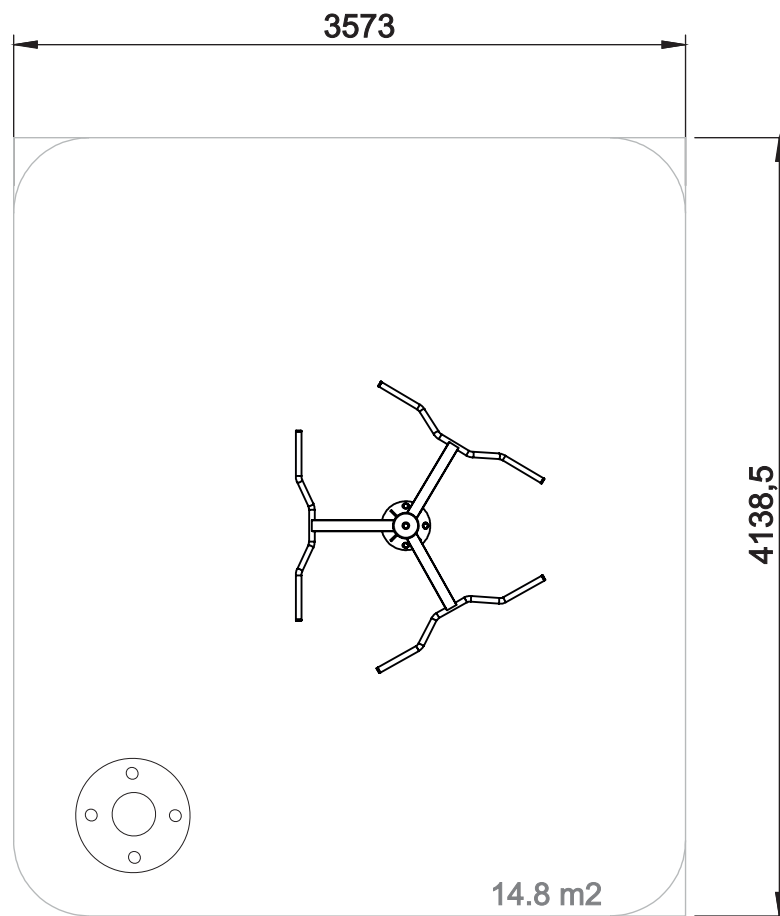

MÚSCULOS PARA DESENVOLVER / MÚSCULOS PARA DESARROLLAR / MUSCLES TO DEVELOP / MUSCLES À DÉVELOPPER

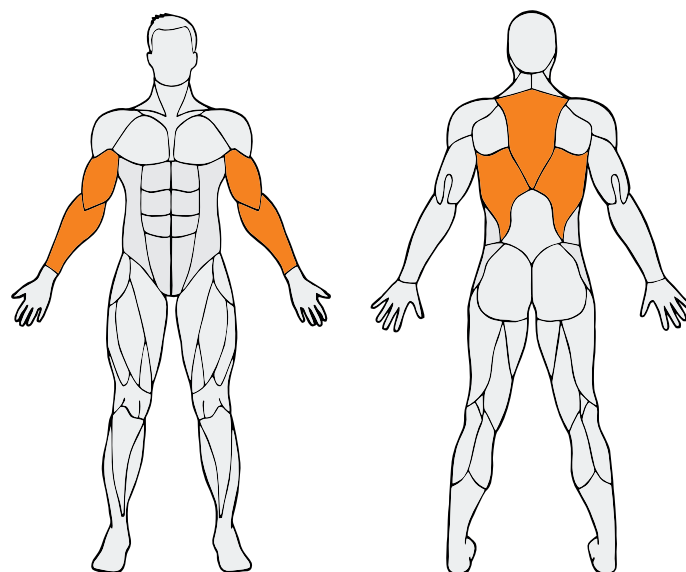



(very resistant to corrosion, wear and vandalism)

Structure

polyethylene

Plastic parts

electro-galvanized steel

Metal parts

Bearings: SKF stiff balls with a reinforced stroke on both sides (no maintenance and lubrication required);

Finishing

electroplated and lacquered (or gel type enamel at 230°C, with thickness between 70µm according to the norm UNE EN ISO2808) to 2600 Sablé (on request can be lacquered to another RAL);

Type of attachment

provided by 1 negative;

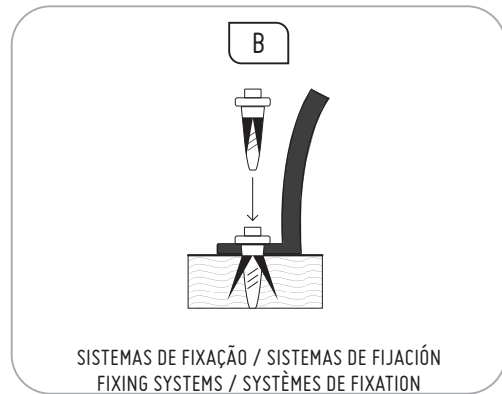

PLANO DE MANUTENÇÃO / PLAN DE MANTENIMIENTO / MAINTENANCE PLAN / PLAN DE MAINTENANCE

Weekly: visually check the overall status of the game, ensuring there are no breaks or damage to users;

Monthly: Check that the joints have a uniform movement. Lubricate if appropriate. ensure that the structural stability of the game is the same as the first day. check the condition of all bolts and their protections;

Annually: check for corrosion on metal parts. Check all foundations;



MODO DE EXECUÇÃO / MODO DE EJECUCIÓN / MODE OF EXECUTION / MODE D'EXÉCUTION

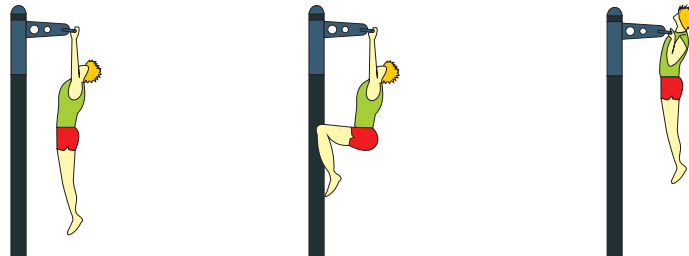

Objective: Strengthen and develop the musculature of the shoulder girdle and upper limbs.

Mode of execution: Grab the blue side bars with both hands, stretch the upper limbs by lifting your body and return to the starting position.

Prescription: Depending on the needs of the person, there is no specification for this device.



Caution: Consult your doctor before performing these exercises. Children must be supervised by an adult.