



Adventure Play







PSTE000.320

Water combination



PSTE000.320

Water combination

-  1-12
-  1 - 12
-  3.4 x 4.2 x 1.7 m
-  5.9 x 6.3 m
-  6.4 x 7.5 m
-  0.9 m

Playfunctions

Waterplay

Material

Made of coated metal and FSC certified Robinien wood

Anchorage

Galvanized steel base plates

Comments

The impact area must have impact absorbing properties belonging to the specified free height of fall. The obstacle-free zone shall be completely free of obstacles.

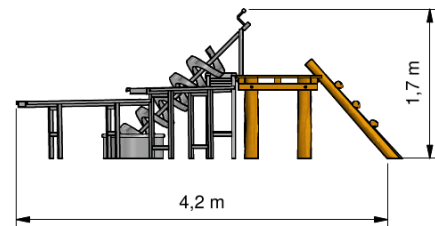
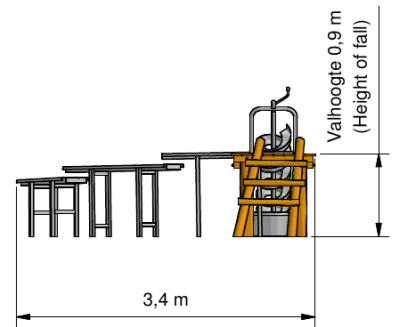
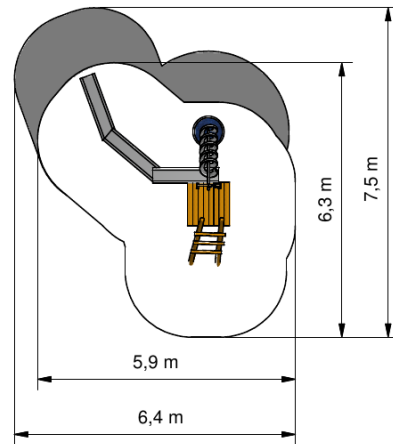

Opvangzone

Impact area

 WAS, Dutch law

 EN1176

Obstakelvrije zone

Obstacle free zone

 WAS, Dutch law

 EN1176

