



Toddler Play







UKPE012.01H

Combination equipment



UKPE012.01H

Combination equipment

-  1+
-  1 - 6
-  2.3 x 0.8 x 1.5 m
-  4.5 x 3.8 m
-  5.0 x 3.8 m
-  0.6 m

Playfunctions

Sliding, climbing

Material

The posts are made of a FSC hardwood with a durability class of 1-2 according to EN 350. The top is covered with a hood. Floors, (climbing) walls and roofs are made of a quality colored HPL laminate. All steel parts are stainless steel. Connections consist of stainless steel and, where necessary, covered with a plastic cap.

Anchorage

The posts go to a depth of 50 cm into the ground with at the bottom a steel plate to increase the support. Concrete is not required.

Comments

If the soil does not contribute to the stability it may be necessary to add concrete.

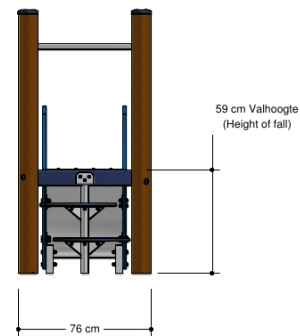
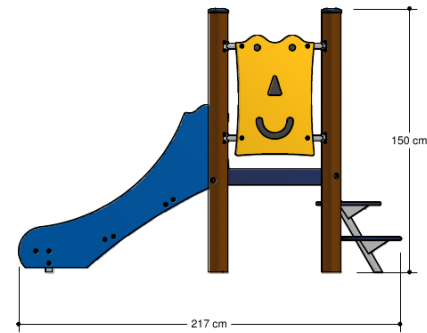
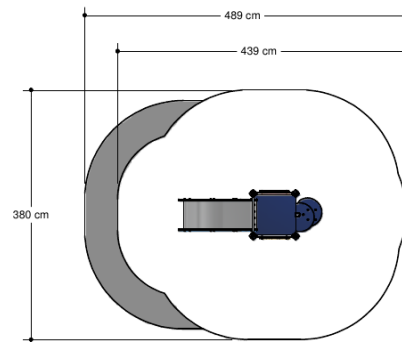

Opvangzone Impact area

 WAS, Dutch law

 EN1176

Obstakelvrije zone Obstacle free zone

 WAS, Dutch law

 EN1176

