





Vippehuske Boletto 2

14-ELBOL001PAL



			
21m ²	0,80m	3-14	02

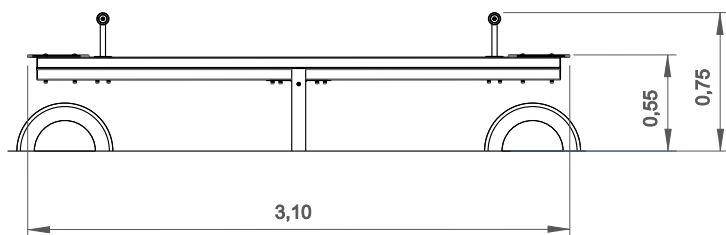
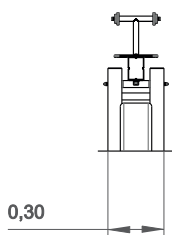

Utilização do equipamento sujeito a condições vigiadas; Zona de segurança: Área mínima requerida pela norma EN 1176-1,6
 Utilización del equipo sujeto a condiciones vigiladas; Zona de seguridad: Área mínima requerida por la norma EN 1176-1,6
 Use of equipment subject to supervised conditions; Safety zone: Minimum area required by EN 1176-1,6
 Utilisation d'équipement soumis à des conditions supervisées; Zone de sécurité: Surface minimale requise par l'EN 1176-1,6





— Zona de impacto

- - Espaço livre

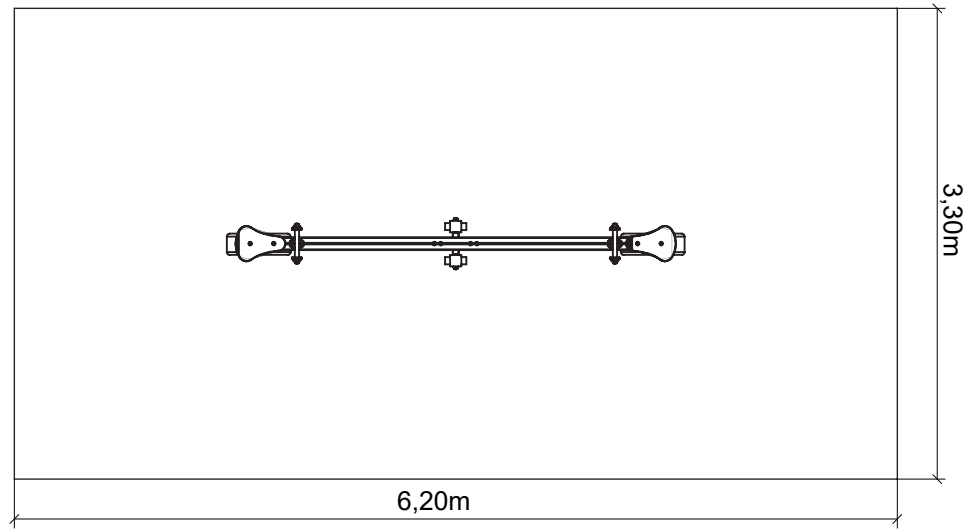
EN 1176-1,6





.....	①
	0,80
	21
	21

0,06 m³



3h



2x



11 KG



32 KG



1 - Assento  0.80m

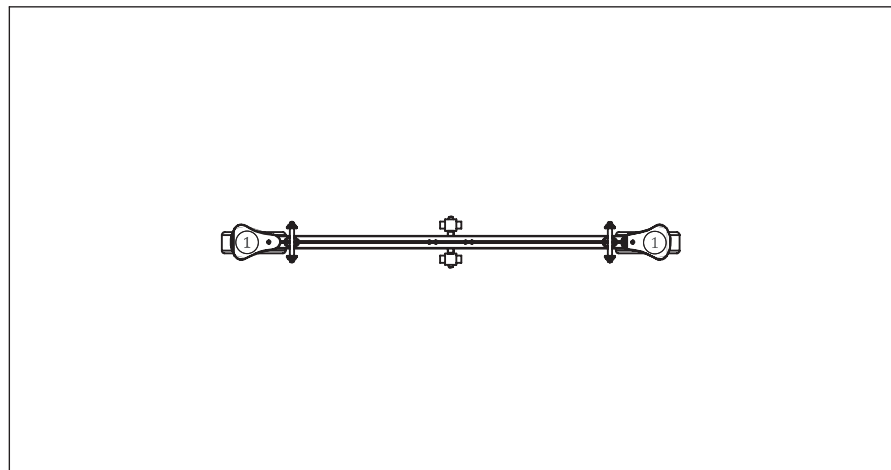



Plums

Aluminum: Profile of 90x90x2.5mm in alloy 6063 and T66 treatment, this is an extrusion alloy par excellence, presents an excellent resistance to corrosion, with a good surface finish. The T66 treatment in which this alloy is solubilized, tempered and artificially aged, aims to improve its mechanical properties. This is supplied to the natural color with the option of being lacquered to the RAL that the customer wants;

Panels

HDPE: High density polyethylene mono or two color. Being a polymer is characterized by its resistance to chemicals and corrosion. Due to its elasticity and lightness, it offers high impact resistance and is very difficult to break. The non-slip surface provides safety for children and its synthetic base prevents the growth of bacteria and fungi. It does not require any maintenance;

Metal parts

Tubes:

Stainless Steel: AISI 304 Ø30mm;

Iron: Anticorrosive hot dip galvanizing treatment according to EN ISO 1461. Lacquering Type gel enamel at 230°C, with thickness between 50 and 70µm, according to the norm UNE EN ISO 2808;

Fixation System:

Type A – Standard fixing system composed of metal base embedded in the ground and cast with concrete;

Type B – Standard fastening system consisting of metal base bolted to the ground with metal bushings;

Screws and accessories

Screws: Zinc-plated steel or optionally AISI 304 stainless steel;

Capsules: PP polypropylene plastic;

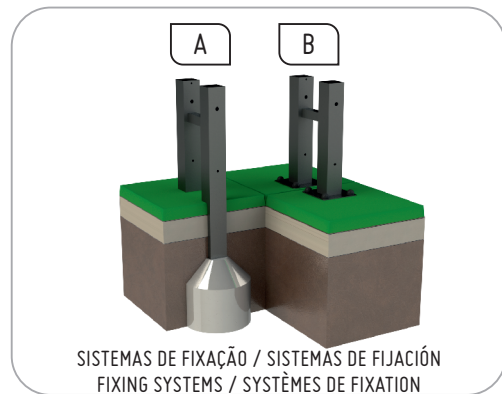

FUNÇÕES LÚDICAS/ FUNCIONES LÚDICAS / RECREATIONAL FUNCTIONS / FONCTIONS RÉCRÉATIVES



Fun

While having fun, children acquire immense abilities, from physical abilities to social interactions.



Socializing

Socialization and imagination are necessary throughout the game. All this creates a relationship between children and awakens the sense of coexistence and solidarity.



Play

Develops patience, sharing and sporting spirit.



Swing

This action helps to develop child balance and teaches you how to control movements with the right balance and vigor, which improves psychomotor activity and coordination of the body.