







SANDVIK PLAY

Spring Lady Bugs

14-ELM0L027



			
18m ²	0,55m	2-8	04

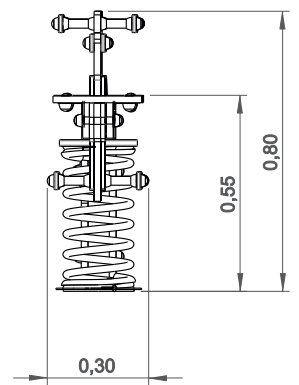
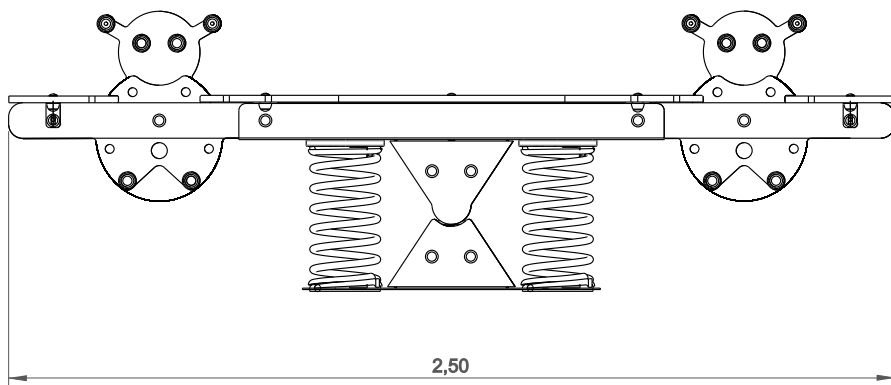

Utilização do equipamento sujeito a condições vigiadas; Zona de segurança: Área mínima requerida pela norma EN 1176-1,6
Utilización del equipo sujeto a condiciones vigiladas; Zona de seguridad: Área mínima requerida por la norma EN 1176-1,6
Use of equipment subject to supervised conditions; Safety zone: Minimum area required by EN 1176-1,6
Utilisation d'équipement soumis à des conditions supervisées; Zone de sécurité: Surface minimale requise par l'EN 1176-1,6



— Zona de impacto
 - - Espaço livre

EN 1176-1,6

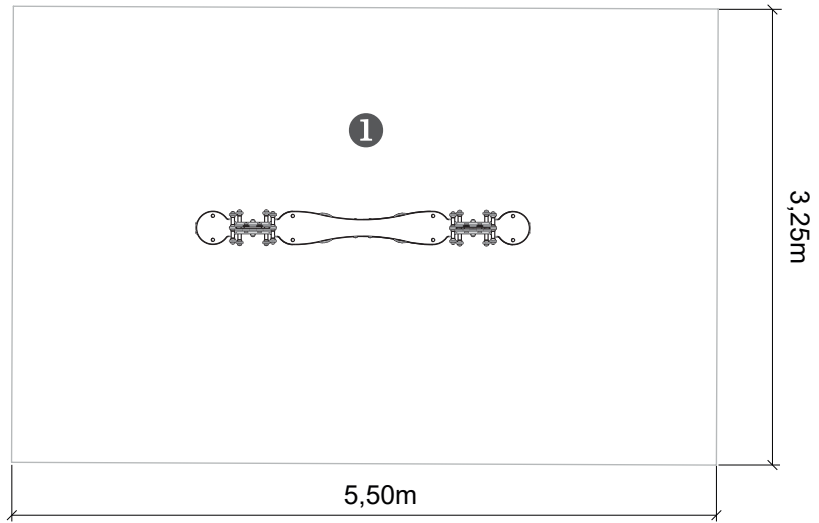

.....	①
	0,55
	18
	18

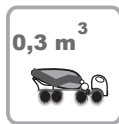

1 - Mola 0.55m

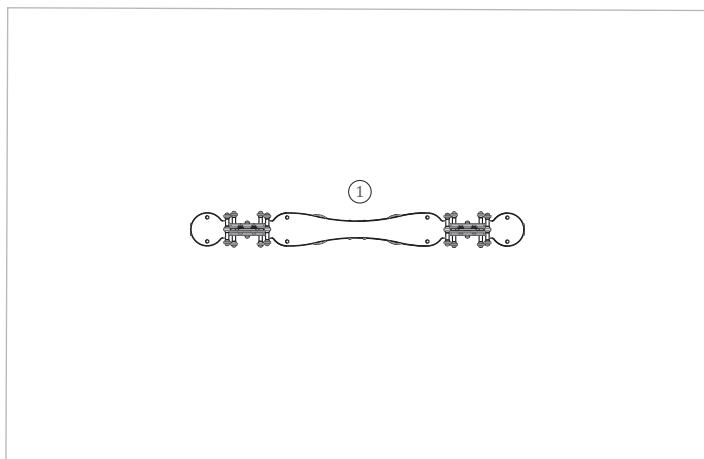



Panels

HDPE: High density polyethylene mono or two color. Being a polymer is characterized by its resistance to chemicals and corrosion. Due to its elasticity and lightness, it offers high impact resistance and is very difficult to break. The non-slip surface provides safety for children and its synthetic base prevents the growth of bacteria and fungi. It does not require any maintenance;

Metal Parts

Spring: Helical spring in steel 35 SCD controlled in magnetoscopic field. The surface is sandblasted and then coated with zinc plating and two layers of 100 micron polyester powder;

Tubes

Stainless steel AISI 304 Ø25mm;

Iron: Anticorrosive hot dip galvanizing treatment according to EN ISO 1461. Lacquering Type gel enamel at 230°C, with thickness between 50 and 70µm, according to the norm UNE EN ISO 2808;

Fixation System

Type A – Standard fixing system composed of metal base embedded in the ground and cast with concrete;

Type B – Standard fastening system consisting of metal base bolted to the ground with metal bushings;

Screws and accessories

Screws: Zinc-plated steel or optionally AISI 304 stainless steel;

Capsules: PP polypropylene plastic;

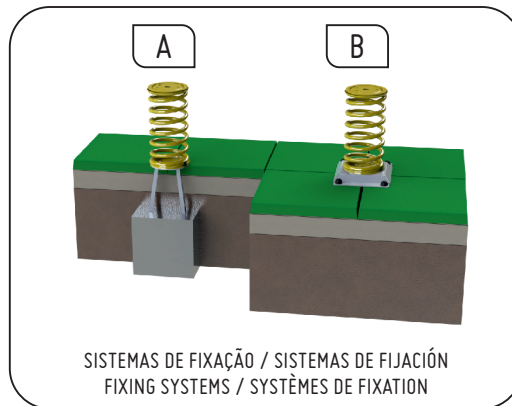

Fun

While having fun, children acquire immense abilities, from physical abilities to social interactions.



Socializing

Socialization and imagination are necessary throughout the game. All this creates a relationship between children and awakens the sense of coexistence and solidarity.



Play

Develops patience, sharing and sporting spirit.



Swing

This action helps to develop child balance and teaches you how to control movements with the right balance and vigor, which improves psychomotor activity and coordination of the body.

